



Microwave antenna UNI3-6

Antenna description

High Performance \varnothing 0.90 m antenna for ALCOMA point to point radiorelay links with holder for precise horizontal and vertical alignment.

General parameters

Diameter	0.90 m (3 ft.)
Feeder	single polarized (dual polarized)
Polarization	horizontal / vertical (dual)
Input flange: - standard - optional	circular, hole diameter 34.00 mm R70 (WR137)
Environmental temperature	-35 °C to +55 °C
Color	light grey
Radom material	white plastic canvas

Electrical parameters

Frequency band	5.900 - 7.100 GHz
Gain: - low band	31.9 dBi
- mid band	32.7 dBi
- high band	33.5 dBi
Beamwidth (-3 dB)	3.2° (H / V)
Return loss	< 1.20 (20.0 dB)
Front to Back Ratio	64 dB
Cross Polarization Discrimination	30 dB
Antenna class	2 (ETSI EN 302 217-4-2)



UNI3-6

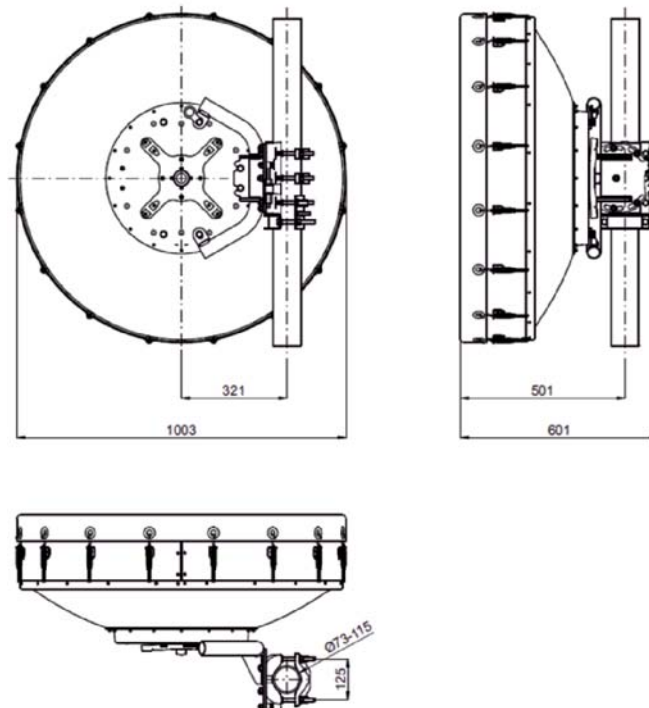

ALCOMA



Microwave antenna UNI3-6

Mechanical parameters due to wind

UNI3-6

Performance stability	max 30 m/s (110 km/h)
Survival	max 55 m/s (200 km/h)
Radial ice load (density 7kN/m ³)	25 mm
Net weight (interface A/R)	26.0 kg
Pipe diameter*	73 - 115 mm
Adjust azimuth / elevation	±180° / —
Fine adjust azimuth	±7°
Fine adjust elevation	±15°

Force and twisting moment due to wind

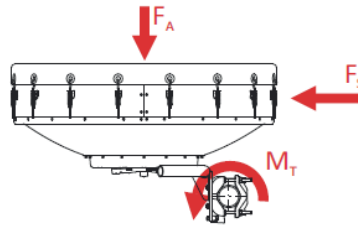

Wind velocity	30 m/s	55 m/s
F_A - axial force	500 N	1850 N
F_s - side force	180 N	570 N
M_T - twisting moment	200 Nm	640 Nm
Icing thickness 25 mm	430 N	