



Microwave antenna UNI4-15

Antenna description

High Performance \varnothing 1.20 m antenna for ALCOMA point to point radiorelay links with holder for precise horizontal and vertical alignment.

General parameters

Diameter	1.20 m (4 ft.)
Feeder	single polarized (dual polarized)
Polarization	horizontal / vertical (dual)
Input flange: - standard - optional	circular, hole diameter 14.30 mm R140 (WR62)
Environmental temperature	-35 °C to +55 °C
Color	light grey
Radom material	white plastic canvas

Electrical parameters

Frequency band	14.200 - 15.350 GHz
Gain: - low band	42.2 dBi
- mid band	42.5 dBi
- high band	42.9 dBi
Beamwidth (-3 dB)	1.2° (H / V)
Return loss	< 1.20 (20.0 dB)
Front to Back Ratio	63 dB
Cross Polarization Discrimination	32 dB
Antenna class	2 (ETSI EN 302 217-4-2)



UNI4-15

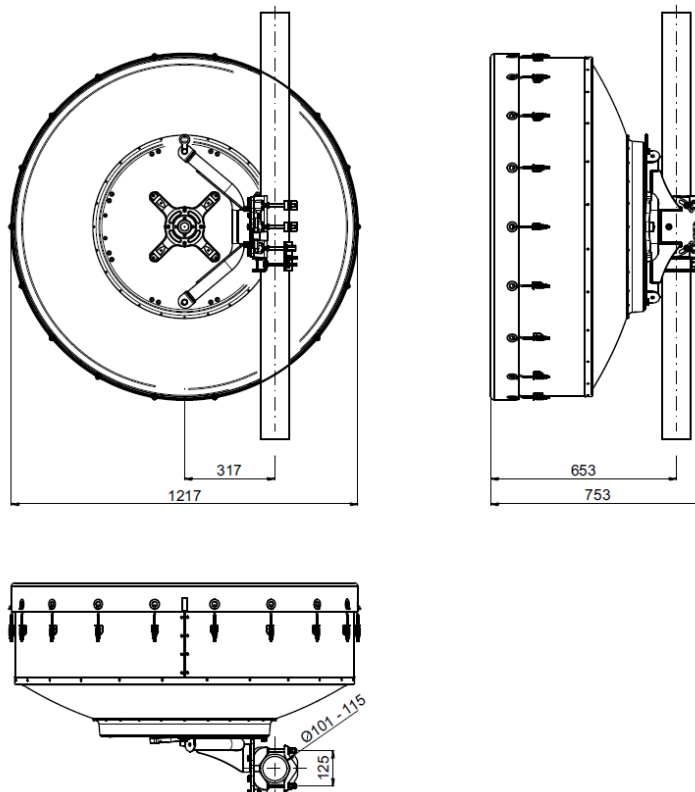

ALCOMA



Microwave antenna UNI4-15

Mechanical parameters due to wind

UNI4-15

Performance stability	max 30 m/s (110 km/h)
Survival	max 55 m/s (200 km/h)
Radial ice load (density 7kN/m ³)	25 mm
Net weight (interface A/R)	34.5 kg
Pipe diameter*	101 - 115 mm
Adjust azimuth / elevation	±180° / —
Fine adjust azimuth	±7°
Fine adjust elevation	±15°

Force and twisting moment due to wind

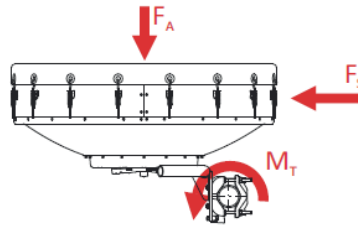

Wind velocity	30 m/s	55 m/s
F_A - axial force	870 N	2850 N
F_s - side force	320 N	1030 N
M_T - twisting moment	350 Nm	1150 Nm
Icing thickness 25 mm	670 N	